

(Hotplate) Magnetic Stirrer

User Manual

LED Digital Hotplate Magnetic Stirrer

LED Digital Magnetic Stirrer

Classic Magnetic Stirrer



Please read the User Manual carefully before use, and follow all operating and safety instructions!

Technical specifications and outline are subject to change without prior notice.

Contents

Preface	1
Service	1
Warranty	1
1. Safety Instructions	2
2. Proper Use	3
3. Inspection	4
3.1 Receiving Inspection	4
3.2 Listing of Items	4
4. Control.....	4
4.1 Control elements.....	4
4.2 Display.....	7
5. Trial Run.....	8
6. Function: Heating (Digital hotplate model).....	8
6.1 Working with external temperature sensor	9
6.2 Residual heat warning (HOT)	9
7. Stirring.....	10
8. Faults	10
9. Maintenance and Cleaning	11
10. Associated Standards and Regulations	11
11. Specifications	12
12. Ordering Information	14

Preface

Welcome to the “(Hotplate) Magnetic Stirrer”. Users should read this Manual carefully, follow the instructions and procedures, and be aware of all the cautions when using this instrument.

Service

When help needed, you can always contact the Service Department of manufacturer for technical support.

Please provide the customer care representative with the following information :

- Serial number (on the rear panel)
- Certification
- Description of problem (i.e., hardware or software)
- Methods and procedures adopted to resolve the problems
- Your contact information

Warranty

This instrument is warranted to be free from defects in materials and workmanship under normal use and service, for a period of 24 months from the date of invoice. The warranty is extended only to the original purchaser. It shall not apply to any product or parts which have been damaged on account of improper installation, improper connections, misuse, accident or abnormal conditions of operation.

For claims under the warranty please contact your local supplier. You may also send the instrument directly to manufacturer, enclosing the invoice copy and by giving reasons for the claim.

1. Safety Instructions



Warning!

- Read the operating instructions carefully before use.
- Ensure that only trained staff works with the instrument.



Risk of burn!

- Caution when touch the housing parts and the hotplate which can reach temperature of 280°C.
- Pay attention to the residual heat after switching off.



Protective ground contact!

- Make sure that socket must be grounded (protective ground contact) before use.

• When working wear personal safety guards to avoid the risk from:

- Splashing and evaporation of liquids
- Release of toxic or combustible gases

• Set up the instrument in a spacious are on a stable, clean, non-slip, dry and fireproof surface. Do not operate the instrument in explosive atmospheres, with hazardous

substances or under water.

- Gradually increase the speed, reduce the speed if:
 - Stirring bar breaks away due to high speed
 - The instrument is not running smoothly, or container moves on the base plate
- Temperature must always be set at least 50°C lower than the fire point of the media used.
- Be aware of hazards due to:
 - Flammable materials or media with a low boiling temperature
 - Overfilling of media
 - Unsafe container
- Process pathogenic materials only in closed vessels.
- Check the instrument and accessories prior to each use. Do not use damaged components. Safe operation is only guaranteed with the accessories described in the “Accessories” chapter. Accessories must be securely attached to the device and can not come off by themselves. Always disconnect the plug before fitting accessories.
- When the external temperature sensor needed, the tip of the measuring sensor must be at least 5-10mm from vessel bottom and wall.

- The instrument can only be disconnected from the main power supply by pulling out the main or the connector plug.
- The voltage stated on the label must correspond to the main power supply.
- Ensure that the main power supply cable does not touch the hotplate. Do not cover the device.
- The instrument may only be opened by experts.
- Keep away from high magnetic field.

2. Proper Use

The instrument is designed for mixing and/or heating liquids in schools, laboratories or factories.

- Observe the minimum distances between the devices, between the device and the wall and above the assembly (min. 100 mm)

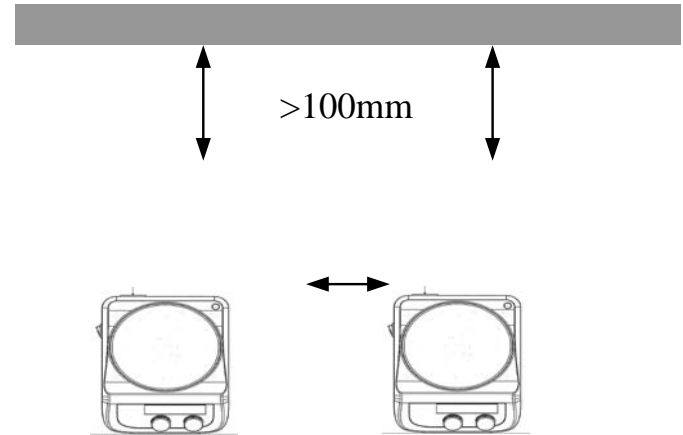

Figure 1

This device is not suitable for using in residential areas or other constraints mentioned in Chapter 1.

3. Inspection

3.1 Receiving Inspection

Unpack the equipment carefully and check for any damages which may have arisen during transport. Please contact manufacturer/supplier for technical support.



Note:

If there is any apparent damage to the system, please do not plug it into the power line.

3.2 Listing of Items

The package includes the following items:

Items	Qty
Main unit	1
Power cable	1
User Manual	1

Table 1

4. Control

4.1 Control elements

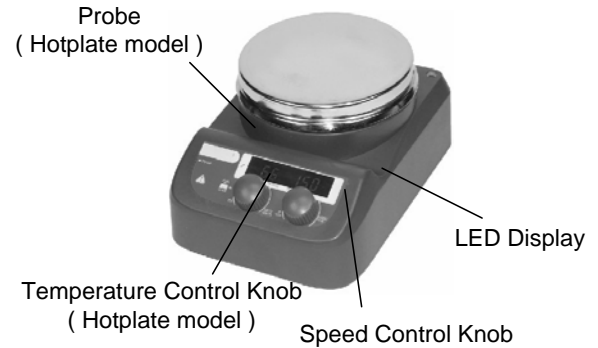

Figure 2 Digital hotplate model

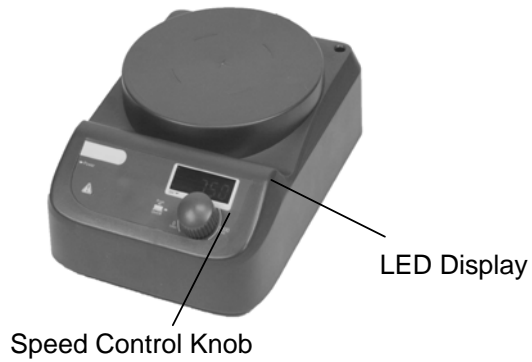

Figure 3 Digital model



Figure 4 Classic model

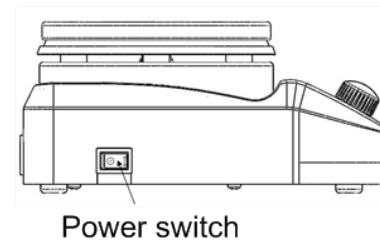

Figure 5

	Items	Descriptions
Digital hotplate model	Temperature Control Knob Heat	Set the temperature parameters. The function “heating” is switched ON or OFF via push ON/OFF knob.
	Speed Control Knob Stir	Set the rotary speed. The function “Stirring” is switched ON or OFF via push ON/OFF knob.
	LED Display	LED displays the real working state and all settings.
	Probe	When the external temperature sensor PT1000 is plugged in, probe icon  is lit.
	Power Switch	Switch ON or OFF the instrument.
Digital model	Temperature Control Knob Stir	Set the rotary speed. The function “Stirring” is switched ON or OFF via push ON/OFF knob.
	LED Display	LED displays the real working state and all settings.
	Power Switch	Switch ON or OFF the instrument.
Classic model	Speed Control Knob Stir	The stirring function is switched ON by rotating the knob.
	Power Switch	Switch ON or OFF the instrument.

Table 2

4.2 Display

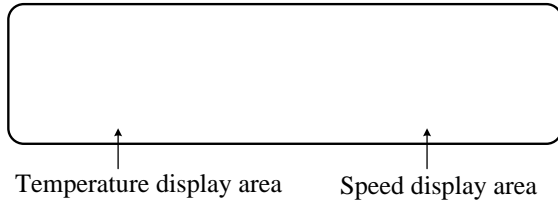

Figure 6 Digital hotplate model

Characters	Descriptions
Temperature display area	When heating function was switched ON, LED displays the temperature setting value and shifts to real value in 5 seconds. When the heating function is switched OFF and the hotplate temperature is still above 50°C, LED displays “Hot”, otherwise LED displays OFF.
Speed display area	When stirring function was switched ON, LED displays the speed setting value and flashes. The setting value does not flash until real speed reaches the set point.

Table 3

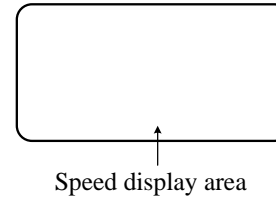

Figure 7 Digital model

Characters	Descriptions
Speed display area	When stirring function was switched ON, LED displays the speed setting value and flashes. The setting value does not flash until real speed reaches the set point.

Table 4

5. Trial Run

- Make sure the required operating voltage and power supply voltage match.
- Ensure the socket must be properly grounded.
- Plug in the power cable, ensure the power is on and begin initializing.
- Add the medium into the vessel with an appropriate stirring bar.
- Place vessel on the work plate.
- Set the target stirring speed and begin.
- Observe the stirring bar and LED display (digital model).
- Set the target temperature and start heating.
- Observe the LED display (digital hotplate model).
- Stop the heating and stirring functions.

If these operations above are normal, the device is ready to operate. If not, the device may be damaged during transportation, please contact manufacturer/supplier for technical support.



Warning !

Forbid to transfer the vessel when the instrument working.

6. Function: Heating (Digital hotplate model)

The device is controlled by digital temperature control technology, which has two separate safe circuits. The hotplate is kept at a constant temperature by a digital control circuit. The hotplate temperature can also be monitored from a separate, adjustable safe circuit. The two temperature sensors internal for temperature control are built into the hotplate. The single external PT1000 can monitor the temperature of sample.

- Plug in the external PT1000.
- Set the temperature via rotating the temperature control knob slowly to the target value.
- When the heating function is switched on, the LED displays the temperature value on the left-hand side.
- The heating function is switched on or off by pushing heating knob.

The instrument automatically displays the last running speed and temperature parameters once turned on.

Generally, the LED screen cannot display the actual temperature of sample in the vessel or hotplate surface, temperature differences as following:

- Hotplate center and outer edge.
- The sample in the vessel and hotplate surface.

In order to ensure the accuracy of the temperature inside the container, please use the external temperature sensor PT1000.

6.1 Working with external temperature sensor

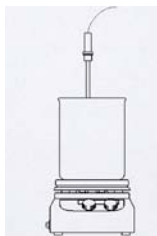

Figure 6

The external temperature sensor PT1000 is the manufacturer's standard accessory. When PT1000 sensor is connected and rotate the temperature control knob, LED displays the temperature setting value and shifts to real value in 5 seconds. Safe circuit controls hotplate temperature under 320°C. Comparing with the temperature control of the hotplate, the external temperature sensor can control the medium's temperature more precise. The

heating function will be stopped automatically under abnormal conditions. Please operate follow the instructions below:

- Switch OFF the instrument.
- Ensure the external temperature sensor is inserted in the media heated.
- Switch ON the instrument and run heating function.

If the heating function does not work, please contact manufacturer/supplier for technical support.

6.2 Residual heat warning (HOT)

In order to prevent the risk of burns from a hotplate, digital hotplate has a residual heat warning function. When the heating function is switched off and the heating plate temperature is still above 50°C, "Hot" will flash to warn that there is a hazard of burns from the hotplate. When the unit is powered off, the LED screen displays the temperature of hotplate and Hot in turn. When the hotplate temperature drops to below 50°C, the unit will automatically switch off. If users want to turn off the LED immediately, just pull out the plug directly. When the plug is pulled out, the residual heat warning function cannot be run.

7. Stirring

The function “stirring” of LED digital model is switched on or off via pushing on/off speed control knob. The speed range of 100 to 1500 rpm and in steps of 10 rpm.

The function “stirring” of classic model is switched on or off via rotating speed control knob. The speed range of 0 to 1500 rpm.

8. Faults

- Instruments can't be power ON
 - Check whether the power line is unplugged
 - Check whether the fuse is broken or loose
- Fault in power on self test
 - Switch OFF the unit, then switch ON and reset the instruments to factory default setting.
- Stir speed cannot reach set point
 - Excessive medium viscosity may cause abnormal speed reduction of the motor
- Unit cannot be powered off when switched off.
 - Check if the residual heat warning function is still ON and hotplate temperature is above 50°C (the LED screen still work and “Hot” flash).

If these faults are not resolved, please contact manufacturer/supplier.

9. Maintenance and Cleaning

- Proper maintenance can keep instruments working properly and lengthen its lifetime.
- Do not spray cleanser into the instrument when cleaning.
- Unplug the power line when cleaning.
- Only use recommended cleansers:

Dyes	Isopropyl alcohol
Construction materials	Water containing tenside / Isopropyl alcohol
Cosmetics	Water containing tenside / Isopropyl alcohol
Foodstuffs	Water containing tenside
Fuels	Water containing tenside

- Before using other method for cleaning or decontamination, the user must ascertain with the manufacturer that this method will not harm the instrument. Wear the proper protective gloves during cleaning of the instrument.



Note:

- Electronic device can not clean with cleanser.

- If you require maintenance service, must be cleaned the instrument in advance to avoid pollution of hazardous substances, and to send back into original packing.
- If the instrument will not use for a long time, please switch off and place in a dry, clean, room temperature and stable location.

10. Associated Standards and Regulations

Construction in accordance with the following safety standards:

- EN 61010-1
- UL 3101-1
- CAN/CSA C22.2(1010-1)
- EN 61010-2-10

Construction in accordance with the following EMC standards:

- EN 61326-1

Associated EU guidelines:

- EMC-guidelines: 89/336/EWG
- Instrument guidelines: 73/023/EWG

Changes or modifications not expressly approved by the party responsible for compliance could void the user's authority to operate the equipment.

NOTE: This equipment has been tested and found to comply with the limits for a Class A digital device, pursuant to Part 15 of the FCC Rules. These limits are designed to provide reasonable protection against harmful interference when the equipment is operated in a commercial environment. This equipment generates, uses, and can radiate radio frequency energy and, if not installed and used in accordance with the instruction manual, may cause harmful interference to radio communications. Operation of this equipment in a residential area is likely to cause harmful interference in which case the user will be required to correct the interference at his own expense.

11. Specifications

Items	Specifications	
	Digital model	Classic model
Voltage [VAC]	*100~120/200~240 100~240	
Frequency [Hz]	50/60	50/60
Power [W]	*515/15	10
Stirring point position quantity	1	1
Max. stirring quantity (H ₂ O) [l]	3	3
Max. magnetic bar [L×∅, mm]	50	50
Motor type	DC motor	
Max. power input of motor [W]	5	5
Max. power output of motor [W]	3	3
Speed range [rpm]	100 – 1500, increment:10	0 – 1500
Rotary speed display	LED	Scale

(Hotplate) Magnetic Stirrer

Items	Specifications		Items	Specifications	
	Digital model	Classic model		Digital model	Classic model
Plate material	*Ceramic coated/Plastic			220×160×75	
Dimensions of workplate (mm)	φ135	φ135	Weight [kg]	*1.4/0.7	0.7
*Heating power [W]	500	-	Permitted ambient temperature [°C]	5—40	
*Temperature range [°C]	RT-280, increment: 1	-	Permitted relative humidity	80%	
*Temperature display [°C]	LED	-	Protection class acc. to DIN 60529	*IP21/IP42	
*Temperature display accuracy [°C]	1	-	*Hotplate model		
*The safe temperature of hotplate [°C]	320	-			
*Temperature sensor in medium	PT1000	-			
*Control accuracy of heating temperature with temperature sensor [°C]	±0.5	-			
*Residual heat warning	50°C	-			
Dimensions (mm)	*220×160×95				

Table 5

12. Ordering Information

Cat No.	Descriptions
01-3101	Double LED Digital Hotplate Magnetic Stirrer, ceramic coated hotplate, USA plug, 100-120V, 50Hz/60Hz
01-3103	Double LED Digital Hotplate Magnetic Stirrer, ceramic coated hotplate, Cn plug, 200-240V, 50Hz/60Hz
01-3104	Double LED Digital Hotplate Magnetic Stirrer, ceramic coated hotplate, Euro plug, 200-240V, 50Hz/60Hz
01-3105	Double LED Digital Hotplate Magnetic Stirrer, ceramic coated hotplate, UK plug, 200-240V, 50Hz/60Hz

*86113122xxxx	Double LED Digital Hotplate Magnetic Stirrer, stainless steel with corrosion-resistant coated hotplate, Euro plug, 200-240V, 50Hz/60Hz
*86113132xxxx	Double LED Digital Hotplate Magnetic Stirrer, stainless steel with corrosion-resistant coated hotplate, UK plug, 200-240V, 50Hz/60Hz
01-3311	LED Digital Magnetic Stirrer, USA plug, 100-240V, 50Hz/60Hz
01-3313	LED Digital Magnetic Stirrer, Cn plug, 100-240V, 50Hz/60Hz
01-3314	LED Digital Magnetic Stirrer, Euro plug, 100-240V, 50Hz/60Hz
01-3315	LED Digital Magnetic Stirrer, UK plug, 100-240V, 50Hz/60Hz

(Hotplate) Magnetic Stirrer

*86152033xxxx	Classic Digital Magnetic Stirrer, UK plug, 100-240V, 50Hz/60Hz	01-3097	Stirrer bar (50mm x 8mm) , 1pc/pk
		01-3090	Stirrer bar remover, 1pc/pk
Accessories		*The last four figures “xxxx” of Cat. No. can be provided by supplier.	
01-3191	PT1000-A Temperature sensor for digital hotplate model, length 230mm	Table 6	
01-3193	PT1000-B Temperature sensor with glass coated, 230mm		
01-3192	Support clamp of PT1000		
01-3181	Reaction block for 50ml round bottom flask(one flask capacity)		
01-3182	Reaction block for 100ml round bottom flask(one flask capacity)		
01-3183	Reaction block for 250ml round bottom flask(one flask capacity)		
01-3184	Reaction block for 500ml round bottom flask(one flask capacity)		
01-3091	Stirrer bar (10mm x 6mm) , 1pc/pk		
01-3092	Stirrer bar (15mm x 8mm) , 1pc/pk		
01-3093	Stirrer bar (20mm x 8mm) , 1pc/pk		
01-3094	Stirrer bar (25mm x 8mm) , 1pc/pk		
01-3095	Stirrer bar (30mm x 6mm) , 1pc/pk		
01-3096	Stirrer bar (40mm x 8mm) , 1pc/pk		